



Vertical Toggle Switches for .100" Grid PC Layout **TT Series**

Refer to Page C18 for Other Options

MATERIAL SPECIFICATIONS:

Contacts	Gold over nickel or silver plate
Case Material	Thermoplastic 94V-0
Terminals/Fixed Contacts	Tin lead plate
Terminal Seal	Epoxy on single pole, optional on double pole
Process Seal	ES version only (see page C15 - C16)

ENVIRONMENTAL SPECIFICATIONS

Operating Temperature	-22°F to +185°F (-30°C to +85°C)
Storage Temperature	-67°F to +185°F (-55°C to +85°C)
Solder Heat Resistance	See page M6-7
U.L. (File E-46765)	Silver only

TYPICAL PERFORMANCE CHARACTERISTICS:

Contact Rating	0.4 VA max. @ 20 VDC or peak AC or 3A @ 125 VAC or 28 VDC (2 pos.), 2 A
Initial Contact Resistance	20 Milliohms max.
Contact Timing	Make before break
Insulation Resistance	1,000 Megohms 500 VDC min.
Dielectric Strength	1,000 Volts RMS @ sea level PA
	Function: 500 volts RMS @ sea level
Plunger/Actuator Travel	26°
High Torque Bushing ShoulderYes
Life Expectancy	See page C18

Part Number Sequence Page C18

APPLICATION NOTE: TT21PA types are usable as SP3T or where a positive Make-Before-Break is needed.

1 POLE

For Terminal Connections refer to Code Chart (see page M8-9)

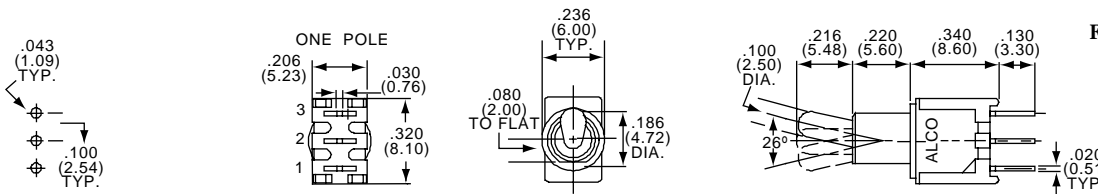

TT11DGPC1

Model	Type	Act. Code	P. M8	↘	↓	↙
TT11AGPC1	SPST	A		On	None	Off
TT11DGPC1	SPDT	D		On	None	On
TT11EGPC1	SPDT	E		On	Off	On

Note: No center terminal on "A" switches

2 POLE

For Terminal Connections refer to Code Chart (see page M8-9)

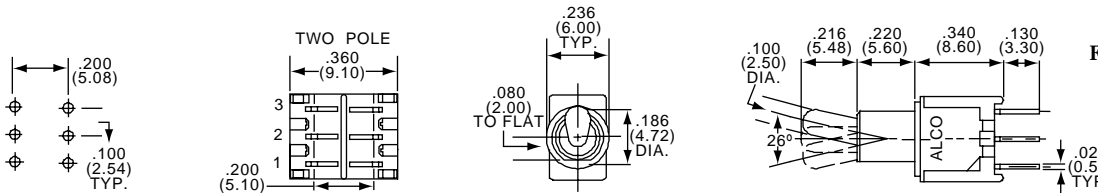

TT21NGPC1

Model	Type	Act. Code	P. M8	↘	↓	↙
TT21KGPC1	DPST	K		On	None	Off
TT21NGPC1	DPDT	N		On	None	On
TT21PGPC1	DPDT	P		On	Off	On
TT21PAGPC1	SP3T	PA		On	On	On

Note: No center terminal on "K" switches

4 POLE

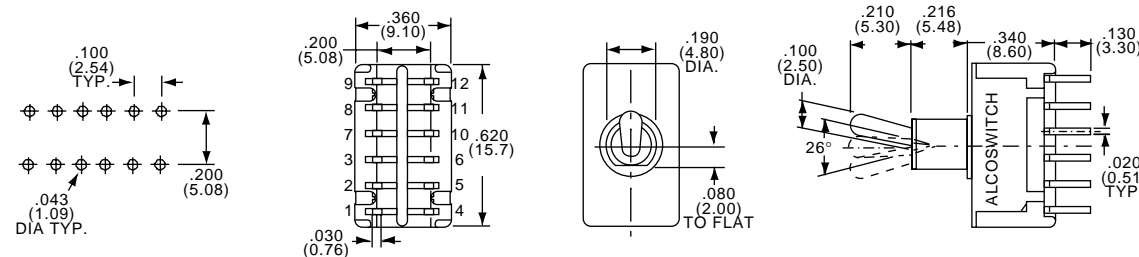

TT41NGPC1

Model	Type	Act. Code	P. M8	↘	↓	↙
TT41NGPC1	4PDT	N		On	None	On

Need more technical information?

Consult your Thomas & Betts sales office listed on the back cover

TT Series *"Vertical and Right Angle" Toggle Switches* for .100" Grid PC Layout



SEE PAGE C9 FOR PRODUCT SPECIFICATIONS

For terminal connections refer to Code Chart on page M8-9

1 & 2 POLE

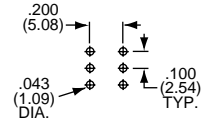
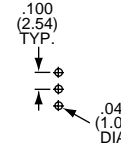
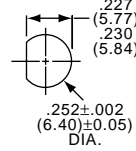
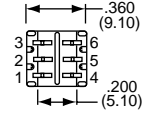
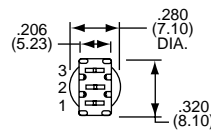
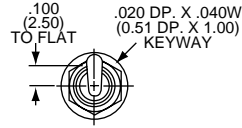
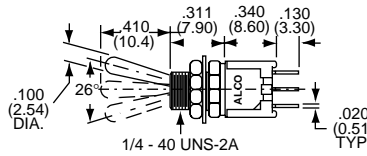
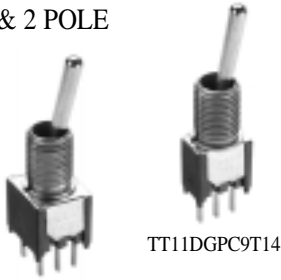

TT21NGPC9T1/4

4 POLE



TT41NGPC9T1/4

Model	Type	Act. Code	P. M8	↖	↓	↗	Model	Type	Act. Code	P. M8	↖	↓	↗
TT11AGPC9T1/4	SPST	A		On	None	Off	TT21NGPC9T1/4	DPDT	N		On	None	On
TT11DGPC9T1/4	SPDT	D		On	None	On	TT21PGPC9T1/4	DPDT	P		On	Off	On
TT11EGPC9T1/4	SPDT	E		On	Off	On	TT21PAGPC9T1/4	SP3T	PA		On	On	On
TT11FGPC9T1/4	SPDT	F		On	None	On	TT21RGC9T1/4	DPDT	R		On	None	(On)
TT11KGPC9T1/4	SPST	F		On	None	(On)	TT41NGPC9T1/4	4PDT	N		On	None	On
TT21KGPC9T1/4	DPST	K		On	None	Off	TT41PGPC9T1/4	4PDT	P		On	Off	On

Note: No center terminal on "A" or "K" switches. (On) indicates momentary position.

1 & 2 POLE



TT11DGVRA1
Vertical Actuation



TT21NGVRA1
Vertical Actuation

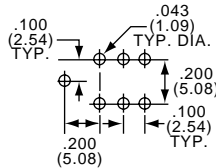
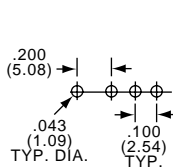
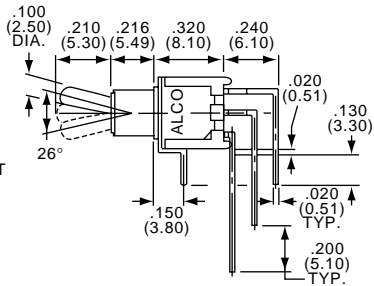
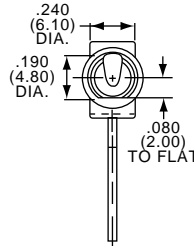
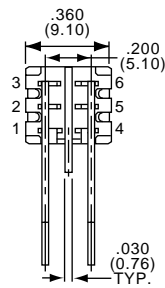
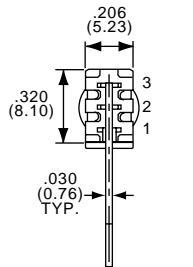

Model	Type	Act. Code	P. M8	↖	↓	↗
TT11DGVRA1	SPDT	D		On	None	On
TT21NGVRA1	DPDT	N		On	None	On
TT21PGVRA1	DPDT	P		On	Off	On

1 & 2 POLE



TT11DGVRA3T
Vertical Actuation



TT21NGVRA3T
Vertical Actuation

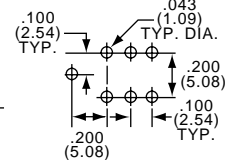
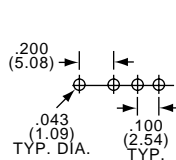
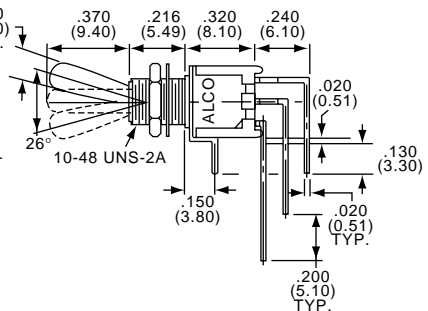
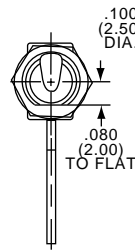
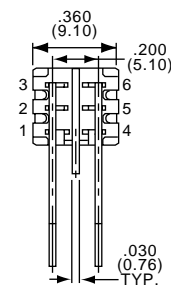
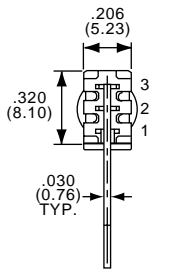

Model	Type	Act. Code	P. M8	↖	↓	↗
TT11DGVRA3T	SPDT	D		On	None	On
TT21NGVRA3T	DPDT	N		On	None	On



Right Angle "Flat" Toggle Switches for .100" Grid TT Series

PC Layout - Refer to Page C18 for Other Options

SEE PAGE C9 FOR PRODUCT SPECIFICATIONS

1 & 2 POLE FLAT

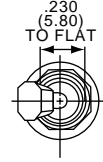
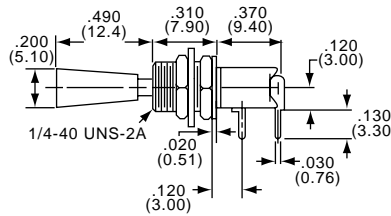
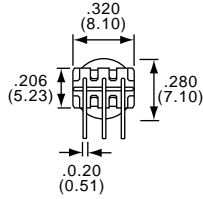
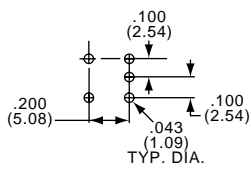

TT11DGRA7T1/4
Horizontal Actuation

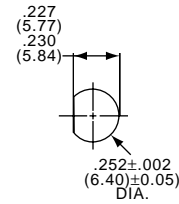
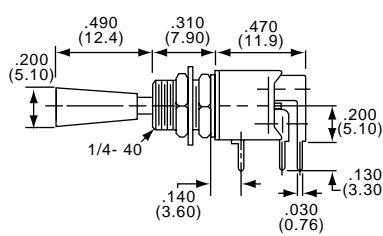
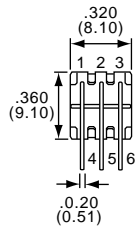
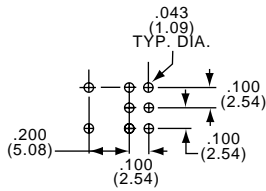

TT21INGRA7T1/4
Horizontal Actuation

Model	Type	Act. Code	P	M8			
TT11DGRA7T1/4	SPDT	D	On	None	On		
TT11EGRA7T1/4	SPDT	E	On	Off	On		
TT11FGRA7T1/4	SPDT	F	On	None	(On)		
TT21INGRA7T1/4	DPDT	N	On	None	On		
TT21PGRA7T1/4	DPDT	P	On	Off	On		
TT21PAGRA7T1/4	SP3T	PA	On	On	On		

(On) indicates momentary position

Pinned for Anti-Rotation

4 POLE FLAT

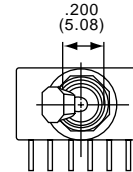
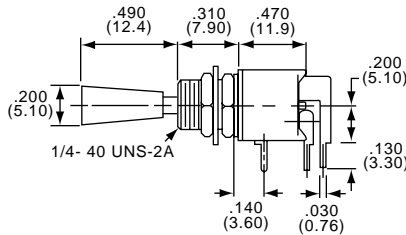
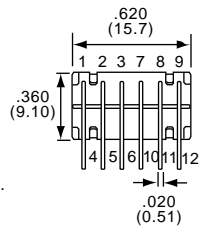
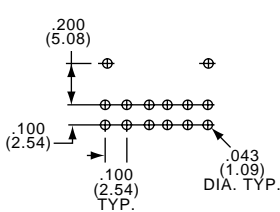

TT41INGRA7T1/4
Horizontal Actuation

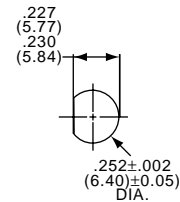

Model	Type	Act. Code	P	M8			
TT41INGRA7T1/4	4PDT	N	On	None	On		

Pinned for Anti-Rotation

Need more technical information?
Consult your Thomas & Betts
sales office listed on the back cover

TT Series "Wire Wrap" Termination Toggle Switches for .100" Grid PC Layout



SEE PAGE C9 FOR PRODUCT SPECIFICATIONS

For terminal connections refer to Code Chart on page M8-9

1 POLE

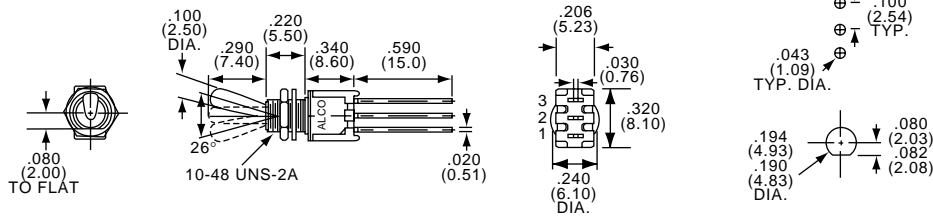

TT11DGWW2T

Model	Type	Act. Code	P. M8	↘	↓	↙
TT11DGWW2T	SPDT	D		On	None	On
TT11EGWW2T	SPDT	E		On	Off	On

2 POLE

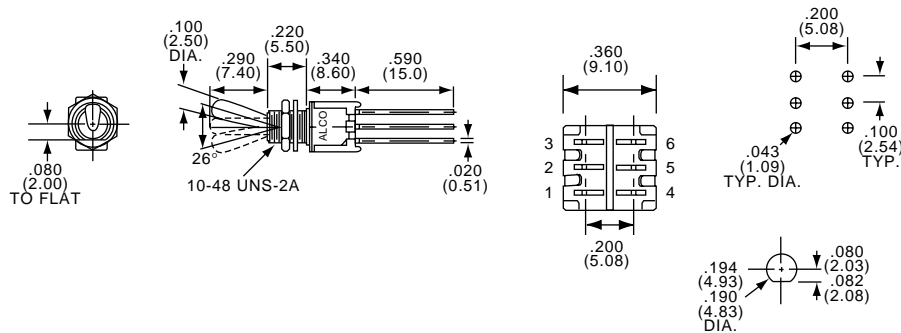

TT21NGWW2T

Model	Type	Act. Code	P. M8	↘	↓	↙
TT21NGWW2T	DPDT	N		On	None	On
TT21PGWW2T	DPDT	P		On	Off	On

4 POLE

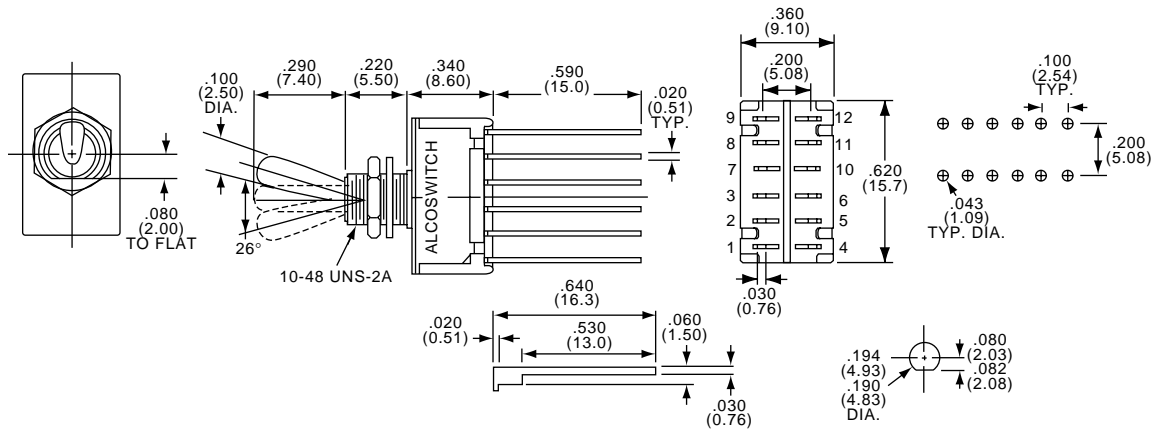

TT41NGWW2T

Model	Type	Act. Code	P. M8	↘	↓	↙
TT41NGWW2T	4PDT	N		On	None	On



"Wire Lug" Termination Toggle Switches TT Series

Round and Flat Actuators

SEE PAGE C9 FOR PRODUCT SPECIFICATIONS
For terminal connections refer to Code Chart on page M8-9

NOTICE: Wire lug terminals accept two No. 20 AWG wires.

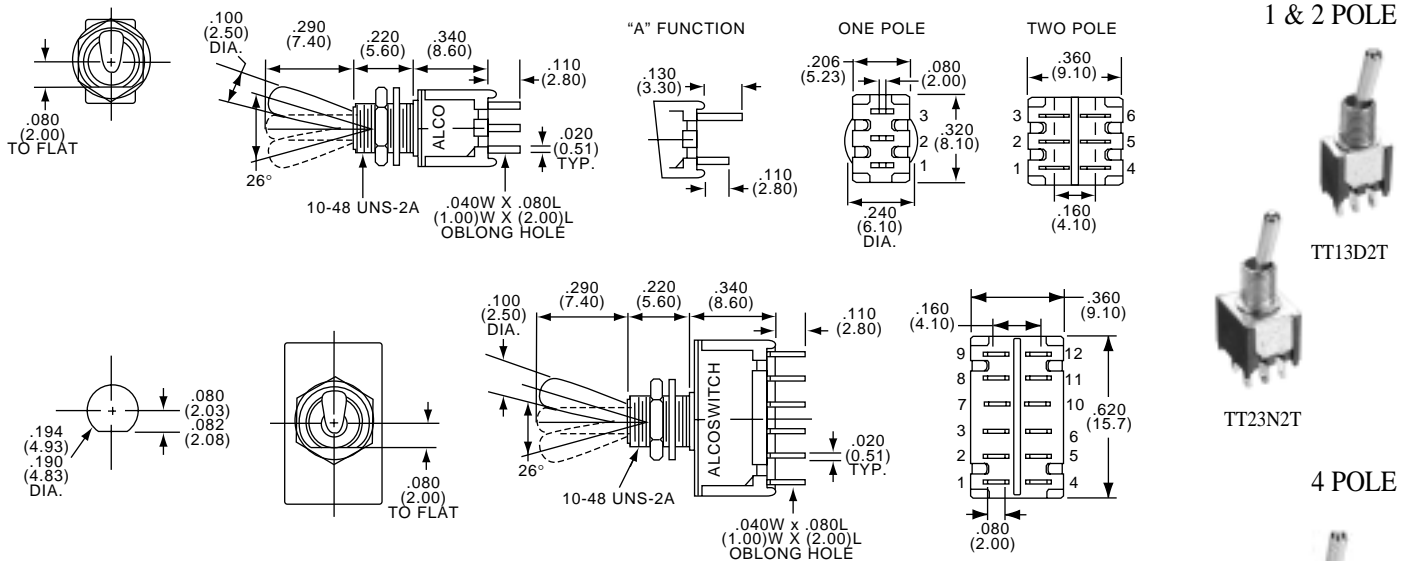

Model	Type	Act. Code	P. M8	↖	↓	↗	Model	Type	Act. Code	P. M8	↖	↓	↗
TT13A2T	SPST	A		On	None	Off	TT23N2T	DPDT	N		On	None	On
TT13D2T	SPDT	D		On	None	On	TT23P2T	DPDT	P		On	Off	On
TT13E2T	SPDT	E		On	Off	On	TT43N2T	4PDT	N		On	None	On
TT23K2T	DPST	K		On	None	Off							

Note: No center terminal "A" or "K" action switches.

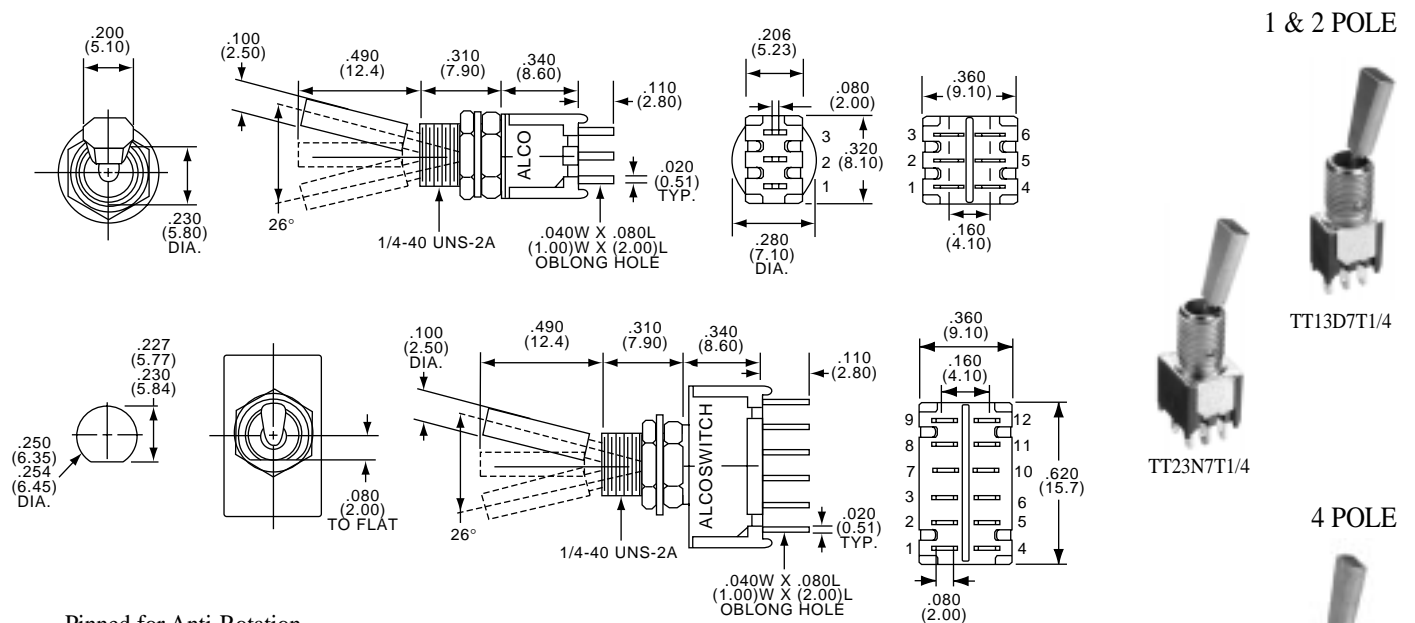

Pinned for Anti-Rotation

Model	Type	Act. Code	P. M8	↖	↓	↗	Model	Type	Act. Code	P. M8	↖	↓	↗
TT13D7T1/4	DPST	N		On	None	On	TT23P7T1/4	DPDT	P		On	Off	On
TT13E7T1/4	DPDT	P		On	Off	On	TT43N7T1/4	4PDT	N		On	None	On
TT23N7T1/4	DPST	N		On	None	On	TT43P7T1/4	4PDT	P		On	Off	On

Need more technical information?
Consult your Thomas & Betts
sales office listed on the back cover

Thomas & Betts
8155 T&B Blvd.
Memphis, TN 38125
(901) 252-5000 FAX (901) 252-1380

TT Series Toggle Switches, Wire Lug Terminations

"Long Actuators"



SEE PAGE C9 FOR PRODUCT SPECIFICATIONS

For terminal connections refer to Code Chart on page M8-9

1 & 2 POLE

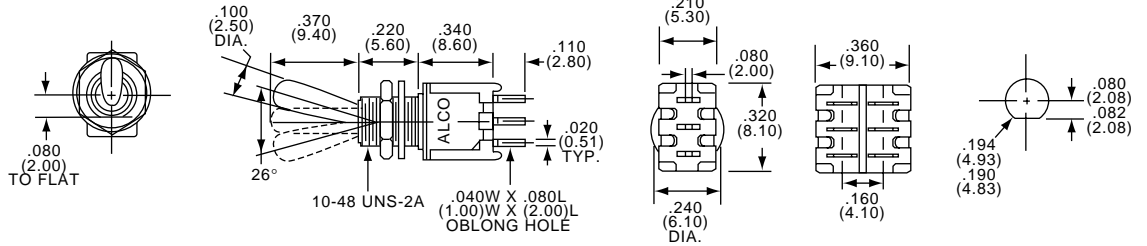

4 POLE

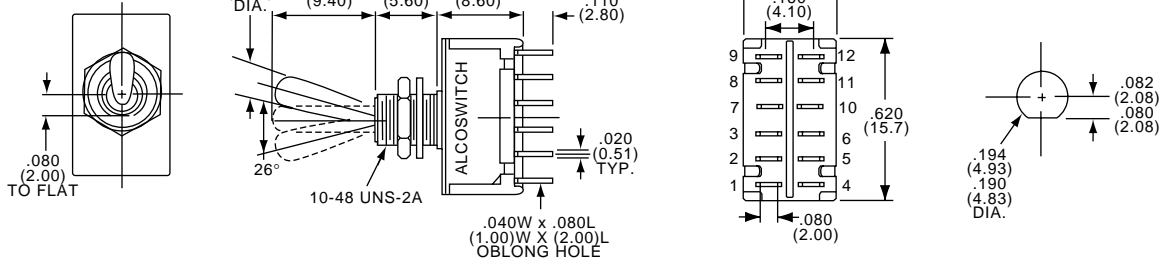

Model	Type	Act.	Code	P. M8				Model	Type	Act.	Code	P. M8			
TT13A3T	SPST	A			On	None	Off	TT23P3T	DPDT	P			On	Off	On
TT13D3T	SPDT	D			On	None	On	TT23PA3T	SP3T	PA			On	On	On
TT13E3T	SPDT	E			On	Off	On	TT43N3T	4PDT	N			On	None	On
TT23K3T	DPST	K			On	None	Off	TT43P3T	4PDT	P			On	Off	On
TT23N3T	DPDT	N			On	None	On								

Note: No center terminal on "A" or "K" action switches.

1 & 2 POLE

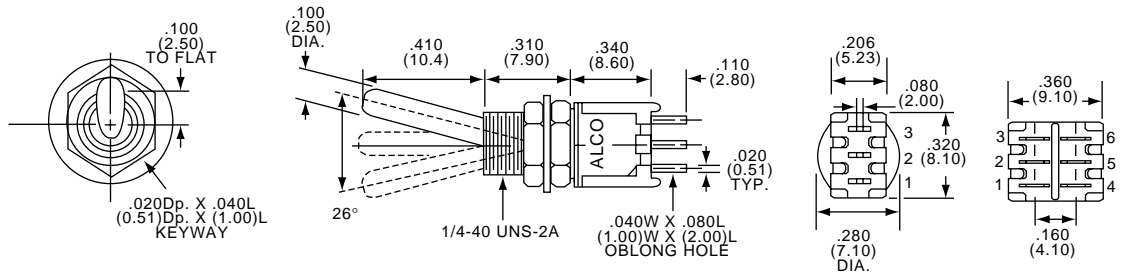

4 POLE

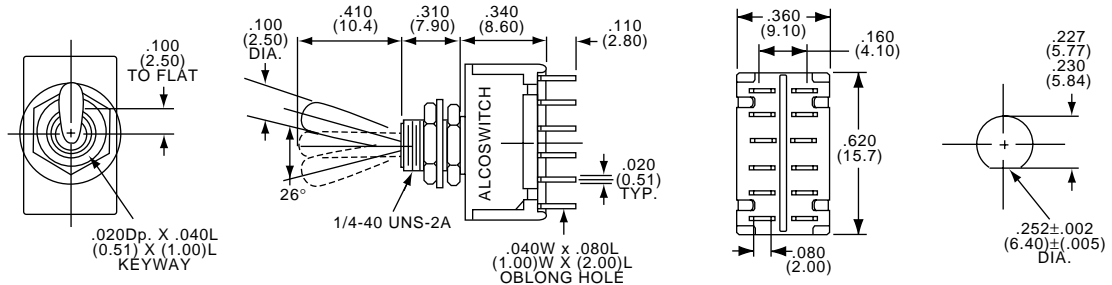

Model	Type	Act.	Code	P. M8				Model	Type	Act.	Code	P. M8			
TT13A9T1/4	SPST	A			On	None	Off	TT23P9T1/4	DPDT	P			On	Off	On
TT13D9T1/4	SPDT	D			On	None	On	TT23PA9T1/4	SP3T	PA			On	On	On
TT13E9T1/4SPDT	SPDT	E			On	Off	On	TT43N9T1/4	4PDT	N			On	None	On
TT23K9T1/4	DPST	K			On	None	Off	TT43P9T1/4	4PDT	P			On	Off	On
TT23N9T1/4	DPDT	N			On	None	On								

Note: No center terminal on "A" or "K" action switches.

Thomas & Betts

Quality & Innovation From **AUGAT** Name Brand Products

C14

Thomas & Betts
8155 T&B Blvd.
Memphis, TN 38125
(901) 252-5000 FAX (901) 252-1380



Actuator/Bushing Options Tiny Toggle Switches

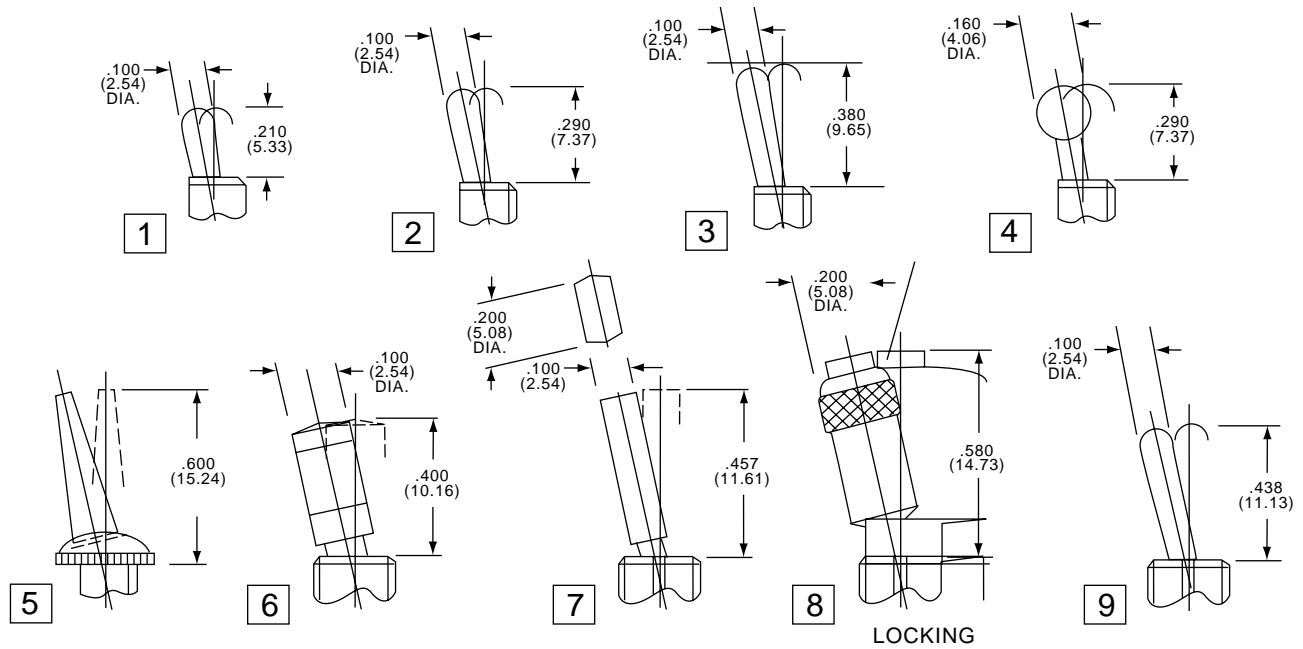

BUSHINGS

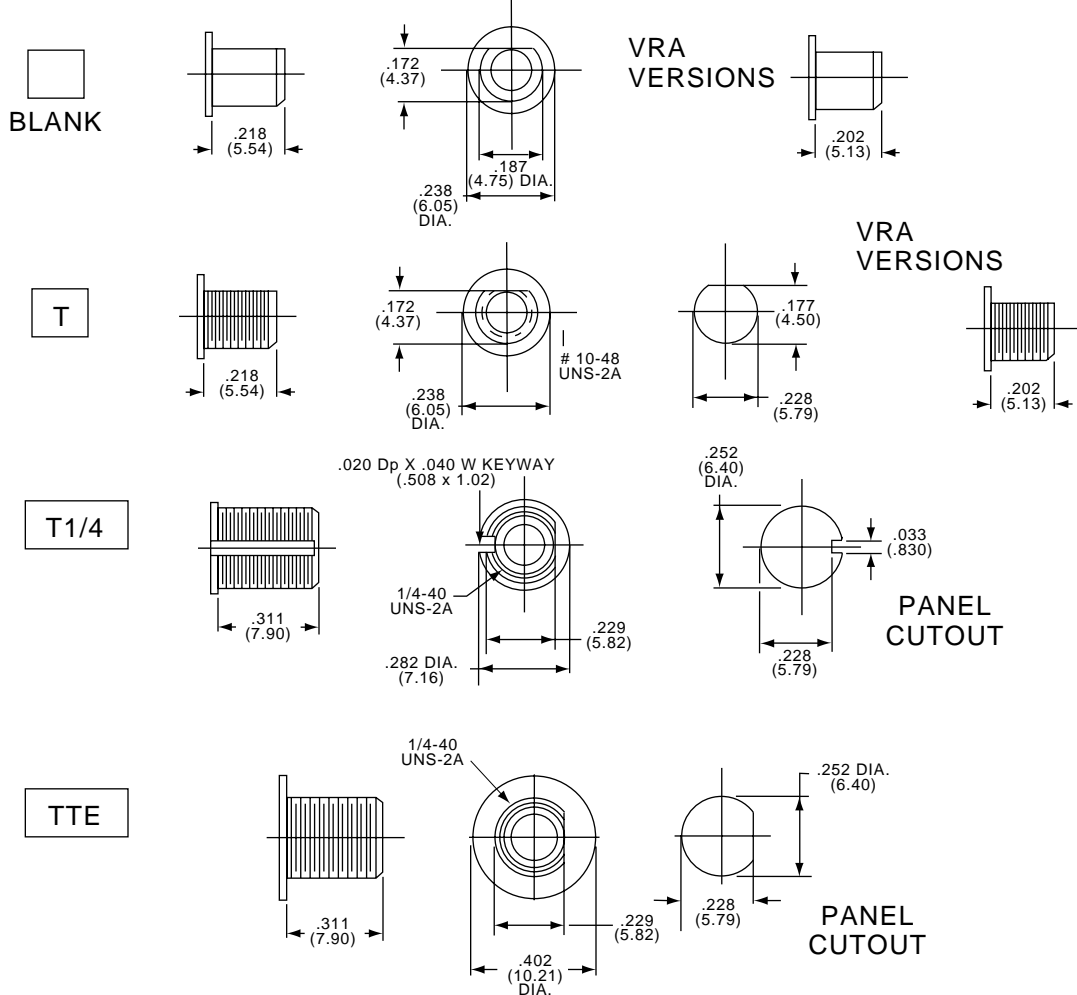

Need more technical information?

Consult your Thomas & Betts sales office listed on the back cover

The Gemini Series "A" Series Toggles 5 Amp

Refer to Pages C32-C36 for Additional Options

"A" SERIES DESIGN FEATURES

- Meets CSA Requirements
- Toggle – Machined brass, heavy nickel plated.
- Bushing & Frame – Rigid one-piece die cast, copper flashed, heavy nickel plated.
- Fixed Contact – Welded construction, selective placement of precious metal. (Gold or silver.)
- Movable Contact – "Captured" design eliminates possibility of displacement due to shock. (01 function.)
- Terminal Seal – Epoxy sealing of terminals is standard.
- Termination – Precious metal(or silver)/brass or copper strip with welded contact area.
- Case – DAP for electrical performance and mechanical strength, UL94VO.

MATERIAL SPECIFICATIONS:

ContactsGold/gold flash
 Silver/tin lead
 Case MaterialThermoset
 Terminal SealEpoxy

ENVIRONMENTAL SPECIFICATIONS

Operating Temperature-20°C to +85°C (-4°F to +185°F)
 Storage Temperature.....-45°C to +100°C (-49°F to +212°F)
 Solder Heat Resistance.....See page M6-7

TYPICAL PERFORMANCE CHARACTERISTICS:

Contact RatingGold: 0.4 VA @ 20 VAC/DC
 Silver: 2 A @ 250 VAC: 5 A @ 125 VAC
 Initial Contact Resistance.....30 Milliohms max.
 Contact TimingBreak before make
 Insulation Resistance1,000 Megohms @ 500 VDC.
 Dielectric Strength1,000 Volts RMS @ sea level
 Actuation ForceMomentary: 950 Grams max.
 Plunger/Actuator TravelMaintained: 1750 Grams max. 25°
 Life Expectancy30,000 Cycles

SPDT



A101SYZQ

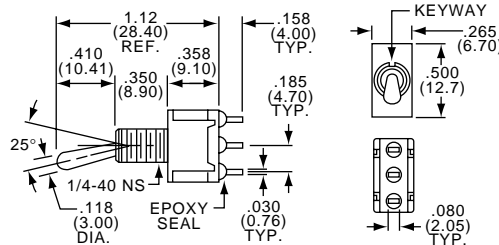

Model	Type	Act. Code	P.M8	↙	↓	↘
Silver Contacts						
A101SYZQ	SPDT	1		On	None	On
A103SYZQ	SPDT	5		On	Off	On
A105SYZQ	SPDT	5		(On)	Off	(On)
A107SYZQ	SPDT	5		On	Off	(On)
A108SYZQ	SPDT	1		On	None	(On)
Gold Contacts						
A101SYZB	SPDT	1		On	None	On
A103SYZB	SPDT	5		On	Off	On
A105SYZB	SPDT	5		(On)	Off	(On)
A107SYZB	SPDT	5		On	Off	(On)

DPDT



A201SYZQ

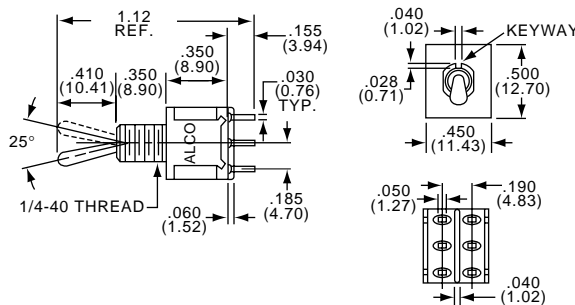

Model	Type	Act. Code	P.M8	↙	↓	↘
Silver Contacts						
A201SYZQ	DPDT	2		On	None	On
A203SYZQ	DPDT	6		On	Off	On
A205SYZQ	DPDT	6		(On)	Off	(On)
A207SYZQ	DPDT	6		On	Off	(On)
A208SYZQ	DPDT	2		On	None	(On)
A211SYZQ	DP3T	11		On	On	On
A213SYZQ	DP3T	11		On	On	(On)
A215SYZQ	DP3T	11		(On)	On	(On)

"A" Series Toggles
Refer to Pages C32-C36 for Additional Options

The Gemini Series

SEE PAGE C24 FOR PRODUCT SPECIFICATIONS

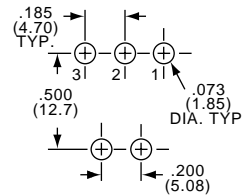
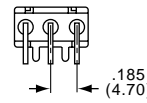
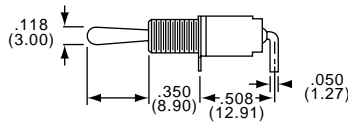
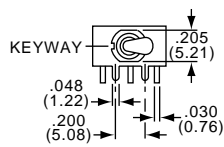

SPDT/DPDT



A101SYAB
Horizontal Actuation

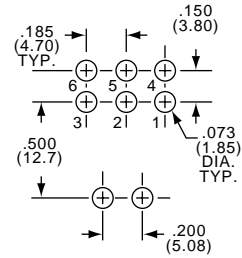
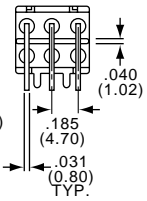
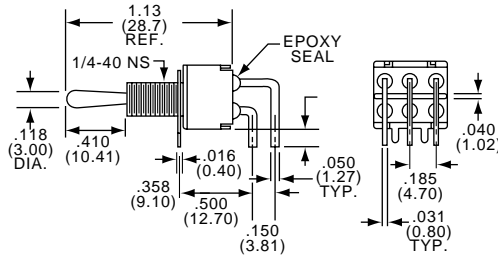
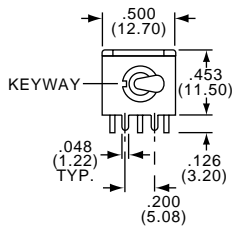

Gold Contacts Model	Type	Act. Code	P.M8			
A101SYAB	SPDT	1	On	None	On	
A103SYAB	SPDT	5	On	Off	On	
A201SYAB	DPDT	2	On	None	On	
A208SYAB	DPDT	2	On	None	(On)	

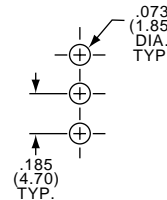
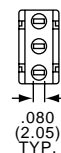
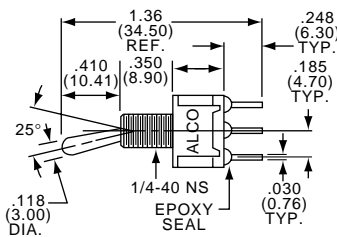
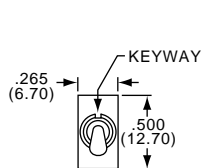

SPDT/DPDT



A101SYCB

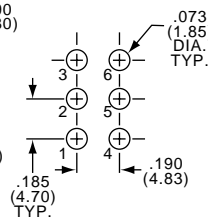
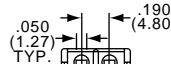
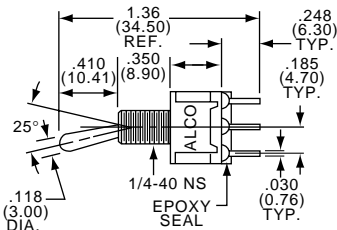
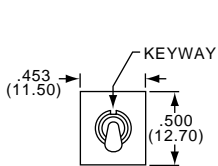

A201SYCB

Gold Contacts Model	Type	Act. Code	P.M8			
A101SYCB	SPDT	1	On	None	On	
A103SYCB	SPDT	5	On	Off	On	
A108SYCB	SPDT	1	On	None	(On)	
A201SYCB	DPDT	2	On	None	On	
A203SYCB	DPDT	6	On	Off	On	
A208SYCB	DPDT	2	On	None	(On)	

Need more technical information?

Consult your Thomas & Betts sales office listed on the back cover

The Gemini Series "A" Series Toggles 5 Amp "Locking Actuator"

Refer to Pages C32-C36 for Additional Options

SEE PAGE C24 FOR PRODUCT SPECIFICATIONS

SPDT



A101SD9AV2Q
Vertical Actuation

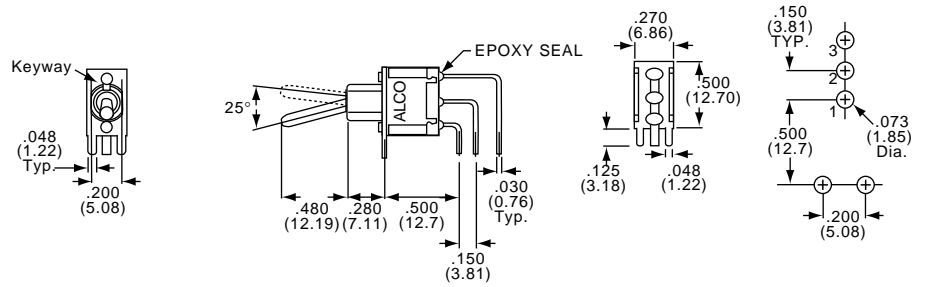

DPDT



A201SD9AV2Q
Vertical Actuation

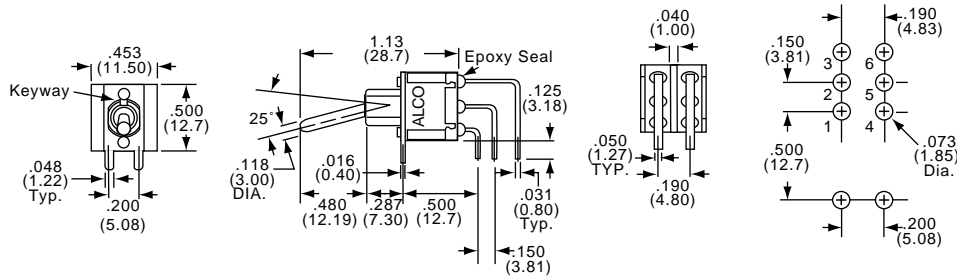

Model	Silver Contacts	Type	Act. Code	P. M8	On	None	On	Model	Silver Contacts	Type	Act. Code	P. M8	On	None	On
A101SD9AV2Q	SPDT	1	On	None	On			A201SD9AV2Q	DPDT	2	On	None	On		
A103SD9AV2Q	SPDT	5	On	Off	On			A203SD9AV2Q	DPDT	6	On	Off	On		
								A208SD9AV2Q	DPDT	2	On	None	(On)		

SPDT



A101KZQ

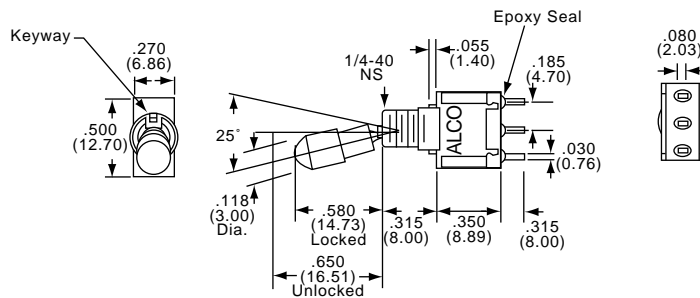

DPDT



A201KZQ

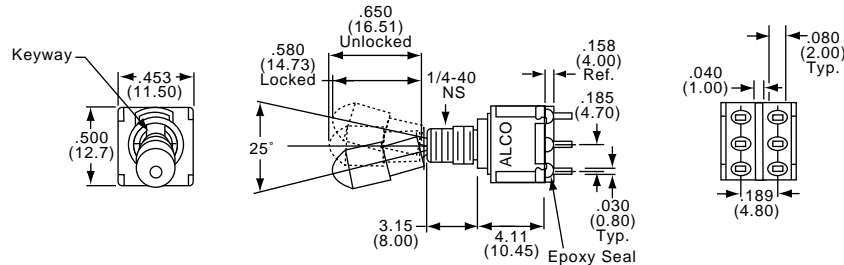

Model	Silver Contacts	Type	Act. Code	P. M8	On	None	On	Model	Silver Contacts	Type	Act. Code	P. M8	On	None	On
A101KZQ	SPDT	1	On	None	On			A201KZB	A201KZQ	DPDT	2	On	None	On	
A103KZQ	SPDT	5	On	Off	On			A203KZB	A203KZQ	DPDT	6	On	Off	On	
								A205KZB	A205KZQ	DPDT	6	(On)	Off	(On)	
								A211KZB	A211KZQ	SP3T	11	On	On	On	

Thomas & Betts

Quality & Innovation From **AUGAT** Name Brand Products

C28

Thomas & Betts
 8155 T&B Blvd.
 Memphis, TN 38125
 (901) 252-5000 FAX (901) 252-1380

The Gemini Series "A" Series Toggles Flat Actuators/Wire Lug

Refer to Pages C32-C36 for Additional Options

SEE PAGE C24 FOR PRODUCT SPECIFICATIONS

SPDT



A101P3YZQ

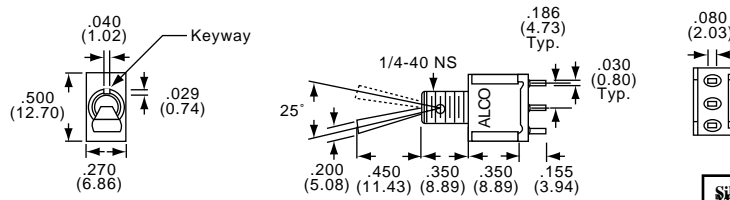

Silver Model	Contacts	Type	Act. Code	P.M8			
A101P3YZQ	SPDT		1		On	None	On
A103P3YZQ	SPDT		5		On	Off	On
A105P3YZQ	SPDT		5		(On)	Off	(On)
A107P3YZQ	SPDT		5		On	Off	(On)
A108P3YZQ	SPDT		1		On	None	(On)

DPDT



A201P3YZQ

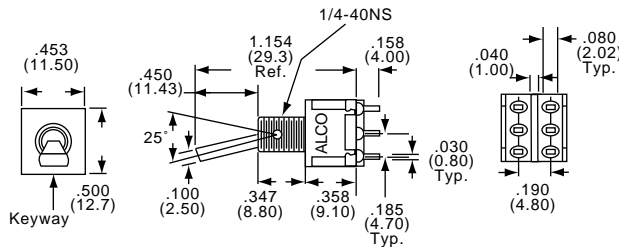

Silver Model	Contacts	Type	Act. Code	P.M8			
A201P3YZQ	DPDT		2		On	None	On
A203P3YZQ	DPDT		6		On	Off	On
A205P3YZQ	DPDT		6		(On)	Off	(On)
A207P3YZQ	DPDT		6		On	Off	(On)
A208P3YZQ	DPDT		2		On	None	(On)
A211P3YZQ	SP3T		11		On	On	On
A215P3YZQ	SP3T		11		(On)	On	(On)

SPDT



A101TZQ

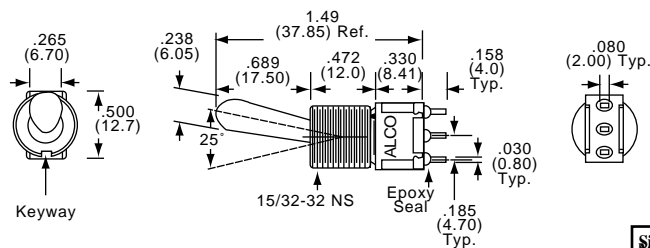

Silver Model	Contacts	Type	Act. Code	P.M8			
A101TZQ	SPDT		1		On	None	On
A103TZQ	SPDT		5		On	Off	On

DPDT



A201TZQ

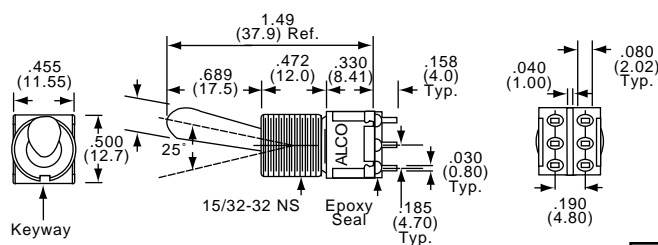

Silver Model	Contacts	Type	Act. Code	P.M8			
A201TZQ	DPDT		2		On	None	On
A203TZQ	DPDT		6		On	Off	On
A211TZQ	SP3T		11		On	On	On

Thomas & Betts

Quality & Innovation From **AUGAT**® Name Brand Products

C30

Thomas & Betts
8155 T&B Blvd.
Memphis, TN 38125
(901) 252-5000 FAX (901) 252-1380



Miniature Bat Toggle/Silver Contacts Standard MTA Series "6 Amp" Wire Lug Termination

MATERIAL SPECIFICATIONS:

Contacts	Gold flash over silver
Actuator Material	Chrome plated copper alloy
Case Material	Thermoset 94V-0
Terminals	Gold flash
Terminal Seal	Insert molded

ENVIRONMENTAL SPECIFICATIONS

Operating Temperature	-20°C to +80°C (-4°F to +176°F)
Storage Temperature	-40°C to +80°C (-40°F to +176°F)
Solder Heat Resistance	See page M6-7

UL Available when ordering . . . Consult factory.

TYPICAL PERFORMANCE CHARACTERISTICS:

Contact Rating	6 A @ 125 VAC, 3 A @ 250 VAC
Initial Contact Resistance	20 Milliohms max.
Contact Timing	Break before make
Insulation Resistance	1,000 Megohms min. @ 500 VDC min. for 1 minute
Dielectric Strength	1,500 VAC
Actuation Force	.05-1.5 kg.
Actuator Travel	24° (26° on MTL Series)
High Torque Bushing Shoulder	Standard
Life Expectancy	See chart below.

NOTICE: For terminal connections refer to Code Chart Page M8-9.

SPDT/DPDT/SP3T

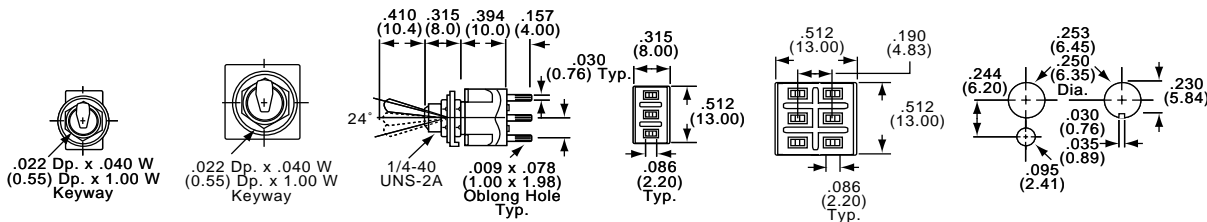

MTA106D



MTA206N

Model	Type	Act. Code	P. M8	On	None	On	Special Details	Model	Type	Act. Code	P. M8	On	None	On	Special Details
MTA106D	SPDT	1		On	None	On	Wire Lug	MTA206N	DPDT	2		On	None	On	Wire Lug
MTA106E	SPDT	5		On	Off	On	Wire Lug	MTA206P	DPDT	6		On	Off	On	Wire Lug
MTA106F	SPDT	1		On	None(On)		Wire Lug	MTA206R	DPDT	2		On	None (On)		Wire Lug
MTA106G	SPDT	5		(On)	Off (On)		Wire Lug	MTA206S	DPDT	6		(On)	Off (On)		Wire Lug
MTA106H	SPDT	5		On	Off (On)		Wire Lug	MTA206T	DPDT	6		On	Off (On)		Wire Lug
(On) indicates momentary position.								*MTA206PA	SP3T	11		On	On (On)		Wire Lug
								*MTA206SA	SP3T	11		(On)	On (On)		Wire Lug
								*MTA206TA	SP3T	11		On	On	On	Wire Lug
								(On) indicates momentary position.							
* Note: PA, SA & TA types have case .100(2.50) longer than other types.															

3PDT/4PDT/DP3T

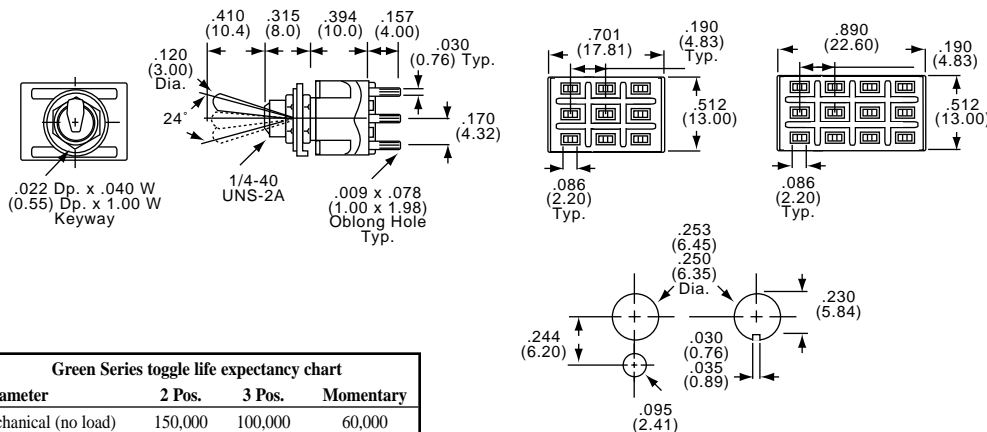

MTA306D



MTA406N

Parameter	2 Pos.	3 Pos.	Momentary
Mechanical (no load)	150,000	100,000	60,000
250AC (3A Resistive)	80,000	60,000	60,000
125AC (6A Resistive)	80,000	60,000	60,000
28DC(4) (Resistive)	60,000	50,000	40,000

Model	Type	Act. Code	P. M8	On	None	On	Special Details	Model	Type	Act. Code	P. M8	On	None	On	Special Details
MTA306D	3PDT	3		On	None	On	Wire Lug	MTA406P	4PDT	8		On	Off	On	Wire Lug
MTA306E	3PDT	7		On	Off	On	Wire Lug	*MTA406PA	DP3T	12		On	On	On	Wire Lug
MTA306F	3PDT	3		On	None (On)		Wire Lug	*Note: PA types have case .100(2.50) longer than other types.							
MTA306H	3PDT	7		On	Off (On)		Wire Lug								
(On) indicates momentary position.															

Need more technical information?

Consult your Thomas & Betts sales office listed on the back cover

MTA-PC Series *Miniature Bat Toggle* "PC Termination" 6 Amp



SEE PAGE C45 FOR PRODUCT SPECIFICATIONS

For terminal connections refer to Code Chart. (See Page M8-9)

SPDT



MTA106DPC

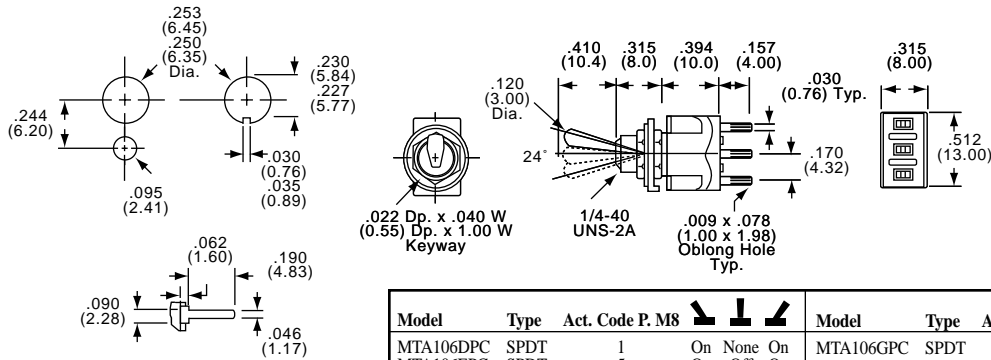

Model	Type	Act.	Code	P. M8	↘	⊥	↗	Model	Type	Act.	Code	P. M8	↘	⊥	↗
MTA106DPC	SPDT	1			On	None	On	MTA106GPC	SPDT	5	(On)	Off	(On)		
MTA106EPC	SPDT	5			On	Off	On	MTA106HPC	SPDT	5			On	Off	(On)
MTA106FPC	SPDT	1			On	None	(On)								

(On) indicates momentary position.

DPDT/SP3T



MTA206NPC

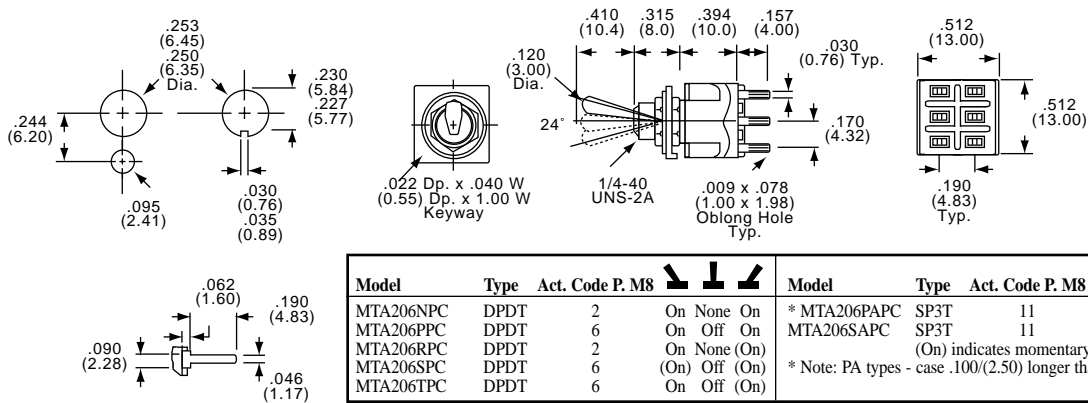

Model	Type	Act.	Code	P. M8	↘	⊥	↗	Model	Type	Act.	Code	P. M8	↘	⊥	↗
MTA206NPC	DPDT	2			On	None	On	* MTA206PAPC	SP3T	11			On	On	On
MTA206PPC	DPDT	6			On	Off	On	MTA206SAPC	SP3T	11			(On)	On	(On)
MTA206RPC	DPDT	2			On	None	(On)								
MTA206SPC	DPDT	6			(On)	Off	(On)								
MTA206TPC	DPDT	6			On	Off	(On)								

(On) indicates momentary position.
* Note: PA types - case .100/(2.50) longer than other types.

3PDT



MTA306DPC

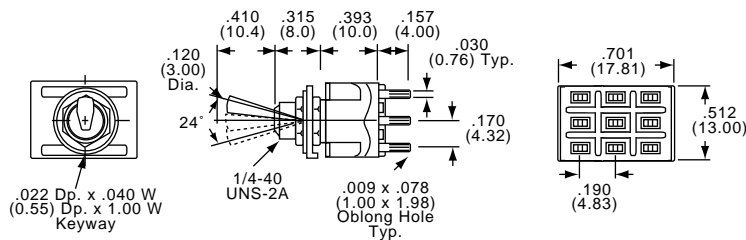

Model	Type	Act.	Code	P. M8	↘	⊥	↗	Model	Type	Act.	Code	P. M8	↘	⊥	↗
MTA306DPC	3PDT	3			On	None	On	MTA306FPC	3PDT	3			On	None	(On)
MTA306EPC	3PDT	7			On	Off	On	MTA306HPC	3PDT	7			On	Off	(On)

(On) indicates momentary position.

4PDT/DP3T



MTA406NPC

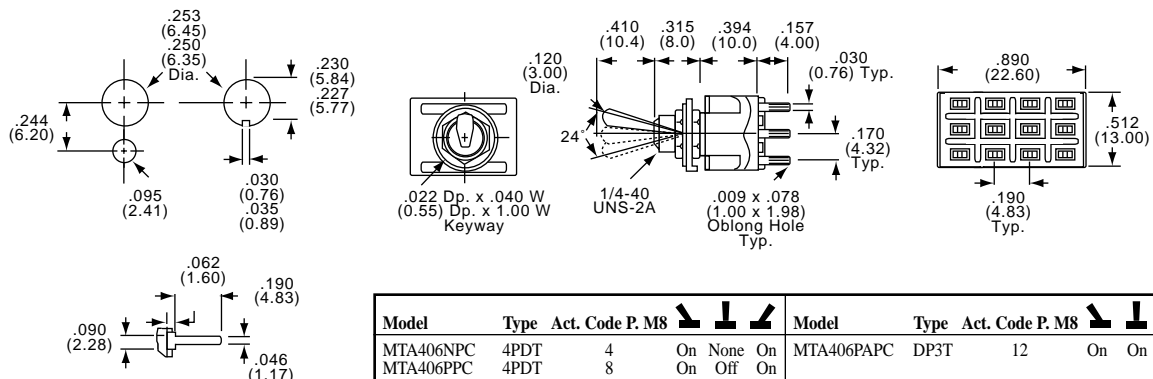

Model	Type	Act.	Code	P. M8	↘	⊥	↗	Model	Type	Act.	Code	P. M8	↘	⊥	↗
MTA406NPC	4PDT	4			On	None	On	MTA406PAPC	DP3T	12			On	On	On
MTA406PPC	4PDT	8			On	Off	On								

Thomas & Betts

Quality & Innovation From **AUGAT** Name Brand Products

C46

Thomas & Betts
8155 T&B Blvd.
Memphis, TN 38125
(901) 252-5000 FAX (901) 252-1380



Miniature Bat Toggle/"Splashproof" w/ 1/4-40 Bushing Wire Lug Termination w/"O-ring" Seal MTE Series

For terminal connections refer to Code Chart. (See Page M8-9)

SEE PAGE C45 FOR PRODUCT SPECIFICATIONS

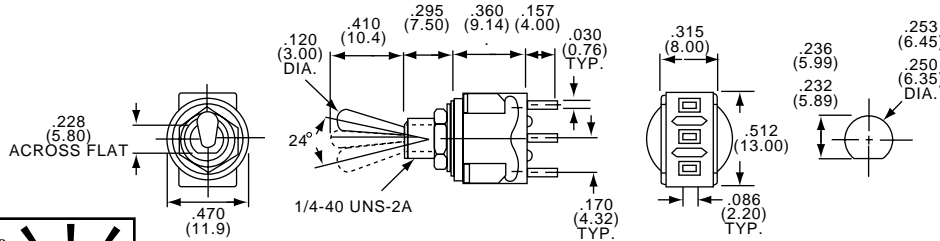
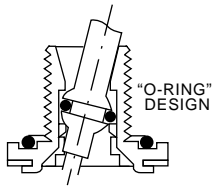

Model	Type	Act. Code	P. M8			
MTE106D	SPDT	1		On	None	On
MTE106E	SPDT	5		On	Off	On
MTE106F	SPDT	1		On	None	(On)
MTE106G	SPDT	5		(On)	Off	(On)
MTE106H	SPDT	5		On	Off	(On)

(On) indicates momentary position.

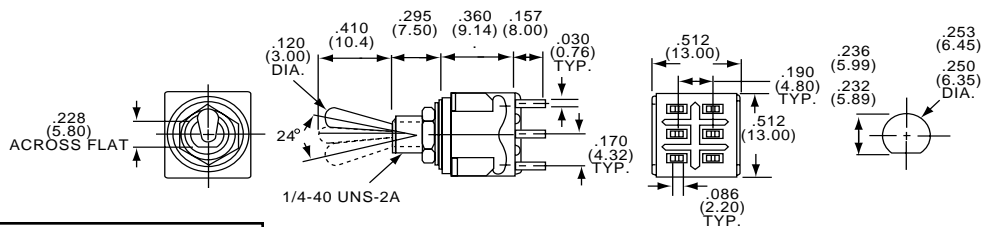

Model	Type	Act. Code	P. M8			
MTE206N	DPDT	2		On	None	On
MTE206P	DPDT	6		On	Off	On
MTE206R	DPDT	2		On	None	(On)
MTE206S	DPDT	6		(On)	Off	(On)
MTE206T	DPDT	6		On	Off	(On)
*MTE206PA	SP3T	11		On	On	On

(On) indicates momentary position.
*Note: PA types have case .100/(2.50) longer than other types.

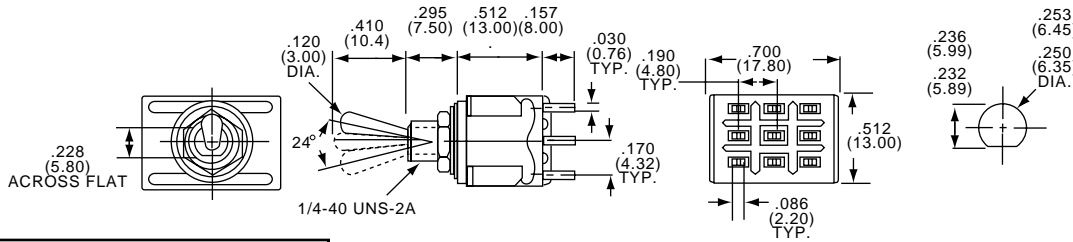

Model	Type	Act. Code	P. M8			
MTE306D	3PDT	3		On	None	On
MTE306E	3PDT	7		On	Off	On

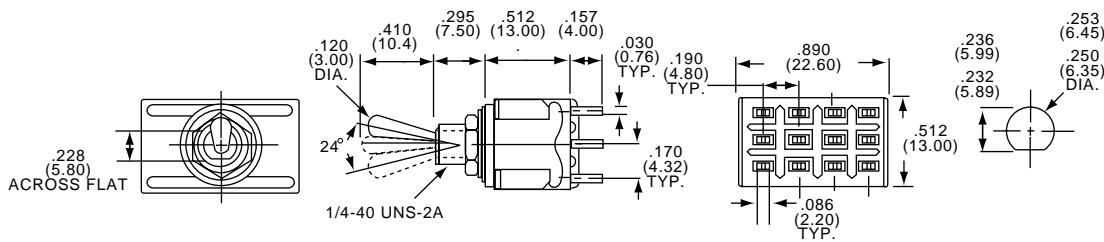

Model	Type	Act. Code	P. M8			
MTE406N	4PDT	4		On	None	On
MTE406P	4PDT	8		On	Off	On

Need more technical information?

Consult your Thomas & Betts sales office listed on the back cover

MTF Series *Miniature "Flat Toggle" 1/4-40 Bushing Wire Lug Termination*



SEE PAGE C45 FOR PRODUCT SPECIFICATIONS

For terminal connections refer to Code Chart. (See Page M8-9)

SPDT



MTF106D

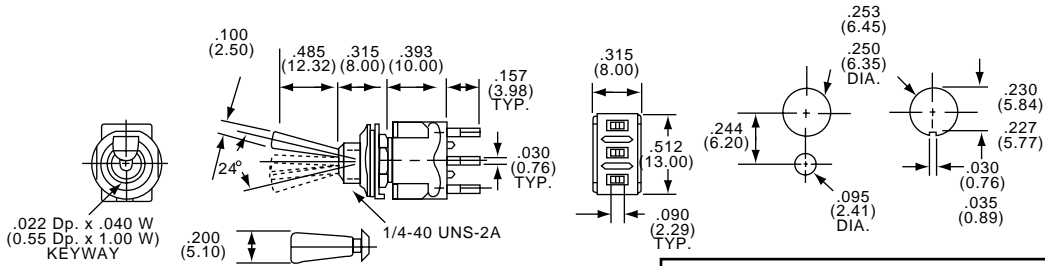

Satin Chrome	Bright Chrome	Type	Act. Code	P. M8	↘	↓	↙
MTF106D	MTF126D	SPDT	1		On	None	On
MTF106E	MTF126E	SPDT	5		On	Off	On
MTF106F	MTF126F	SPDT	1		On	None	(On)
MTF106G	MTF126G	SPDT	5		(On)	Off	(On)
MTF106H		SPDT	5		On	Off	(On)

(On) indicates momentary position.

DPDT/SP3T



MTF206N

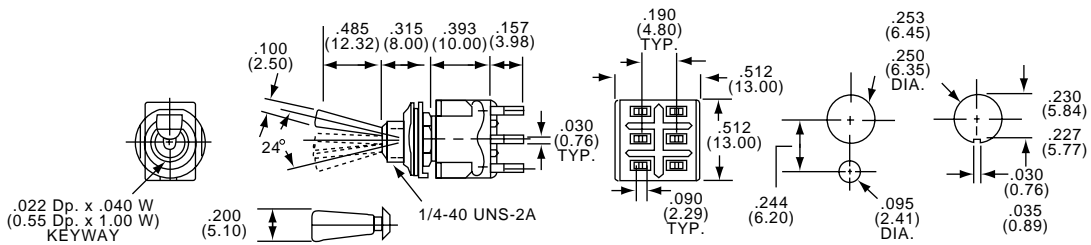

Satin Chrome	Bright Chrome	Type	Act. Code	P. M8	↘	↓	↙
MTF206N	MTF226N	DPDT	2		On	None	On
MTF206P	MTF226P	DPDT	6		On	Off	On
MTF206R		DPDT	2		On	None	(On)
MTF206S	MTF226S	DPDT	6		(On)	Off	(On)
MTF206T		DPDT	6		On	Off	(On)
*MTF206PA	*MTF226PA	SP3T	11		On	On	On
*MTF206SA	*MTF226SA	SP3T	11		(On)	On	(On)

*Note: PA & SA types have case .100(2.50) longer than other types.

3PDT



MTF306D

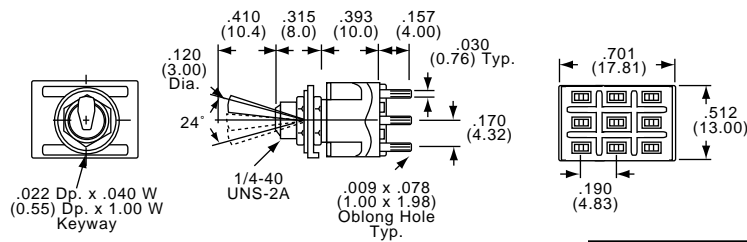

Satin Chrome	Bright Chrome	Type	Act. Code	P. M8	↘	↓	↙
MTF306D	MTF326D	3PDT	3		On	None	On

4PDT



MTF406N

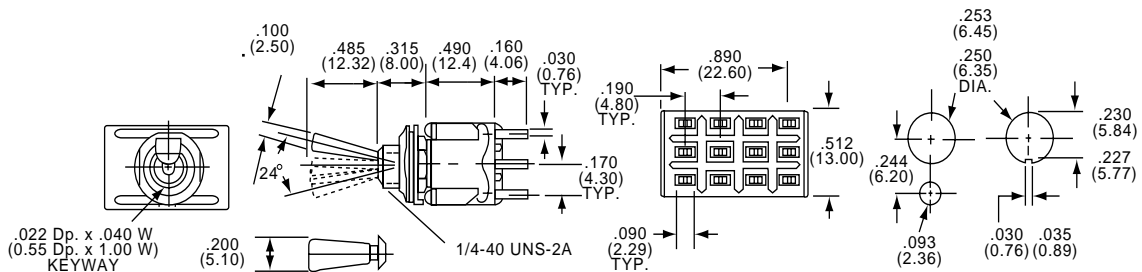

Satin Chrome	Bright Chrome	Type	Act. Code	P. M8	↘	↓	↙
MTF406N	MTF426N	4PDT	4		On	None	On

Thomas & Betts

Quality & Innovation From **AUGAT** Name Brand Products

C50

Thomas & Betts
8155 T&B Blvd.
Memphis, TN 38125
(901) 252-5000 FAX (901) 252-1380

For terminal connections refer to Code Chart. (See Page M8-9)

SEE PAGE C45 FOR PRODUCT SPECIFICATIONS

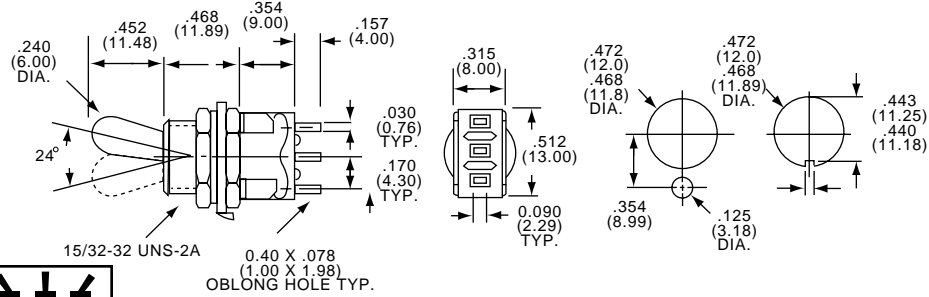
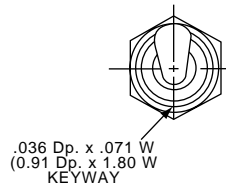

Model	Type	Act. Code P. M8	↗	↓	↘
MTG106D	SPDT	1	On	None	On
MTG106E	SPDT	5	On	Off	On
MTG106F	SPDT	1	On	None	(On)
MTG106G	SPDT	5	(On)	Off	(On)
MTG106H	SPDT	5	On	Off	(On)

(On) indicates momentary position.

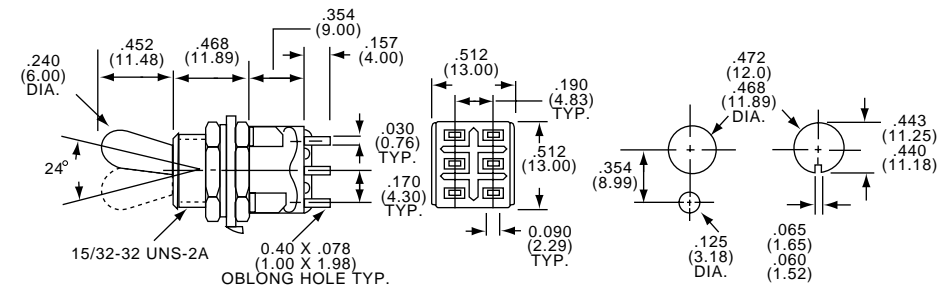
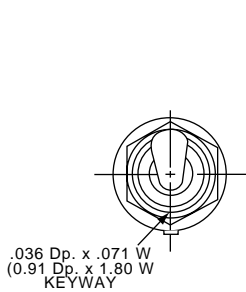

Model	Type	Act. Code P. M8	↗	↓	↘	Model	Type	Act. Code P. M8	↗	↓	↘
MTG206N	DPDT	2	On	None	On	MTG206S	DPDT	2	(On)	Off	(On)
MTG206P	DPDT	6	On	Off	On	*MTG206T	DPDT	6	On	Off	(On)
MTG206R	DPDT	2	On	None	(On)	*MTG206PA	SP3T	11	On	On	On

(On) indicates momentary position.
*Note: PA types have case .100/(2.50) longer than other types.

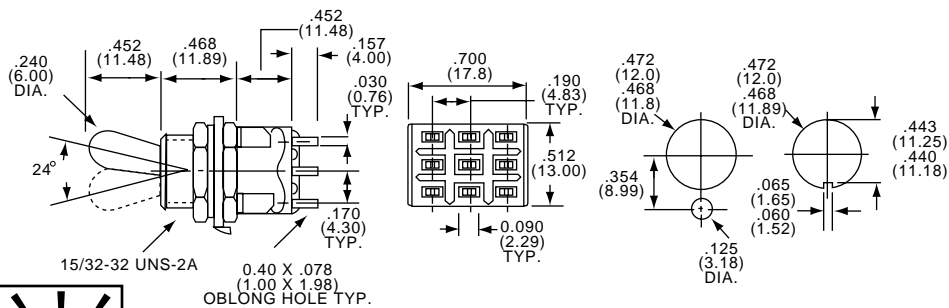
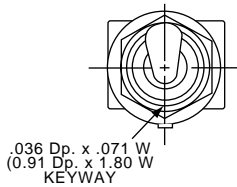

Model	Type	Act. Code P. M8	↗	↓	↘
MTG306D	3PDT	3	On	None	On
MTG306E	3PDT	7	On	Off	On

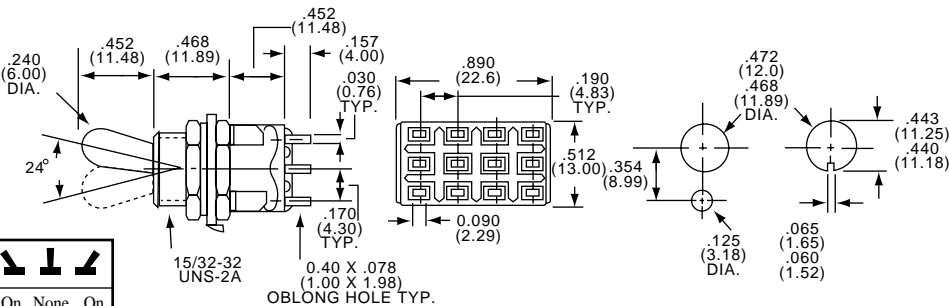
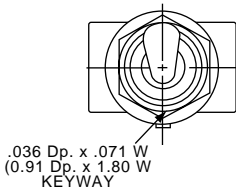

Model	Type	Act. Code P. M8	↗	↓	↘
MTG406N	4PDT	4	On	None	On
MTG406P	4PDT	8	On	Off	On



Need more technical information?
Consult your Thomas & Betts
sales office listed on the back cover

For terminal connections refer to Code Chart. (See Page M8-9) SEE PAGE C45 FOR PRODUCT SPECIFICATIONS

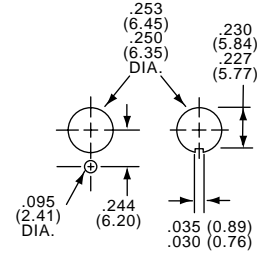
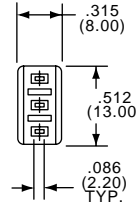
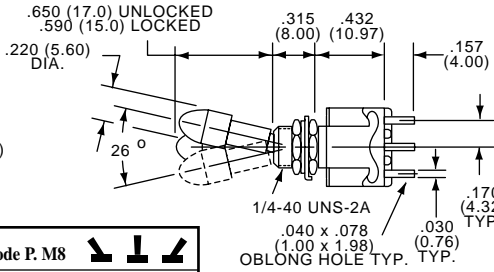
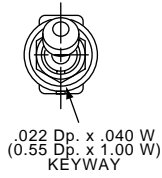

MTL106L

Model	Type	Act. Code P. M8			
MTL106D	SPDT	1	On	None	On
MTL106E	SPDT	5	On	Off	On

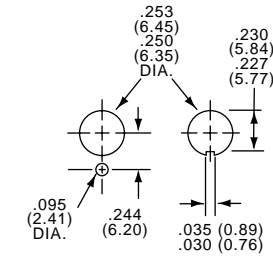
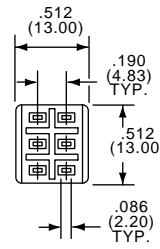
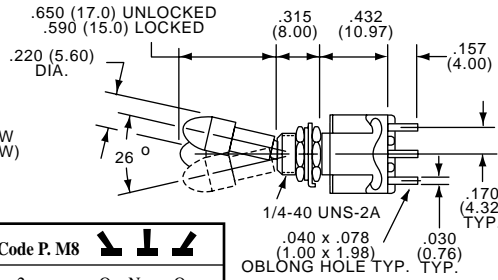
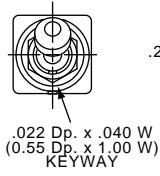

DPDT/SP3T



MTL206N

Model	Type	Act. Code P. M8			
MTL206N	DPDT	2	On	None	On
MTL206P	DPDT	6	On	Off	On
MTL206S	DPDT	6	(On)	Off	(On)
*MTL206PA	SP3T	11	On	On	On

(On) indicates momentary position.
*Note: PA types have case .100(2.50) longer than other types.

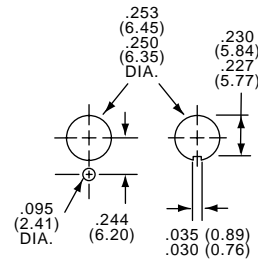
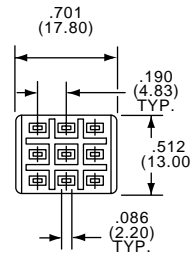
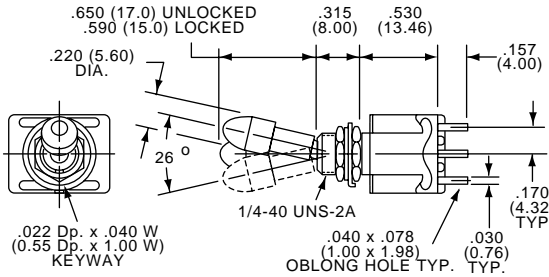

3PDT



MTL306D

Model	Type	Act. Code P. M8			
MTL306D	3PDT	3	On	None	On

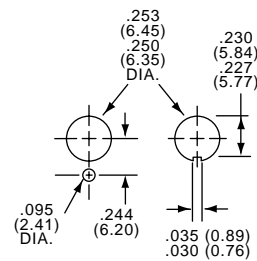
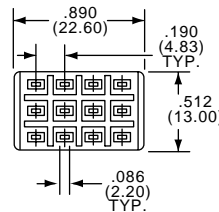
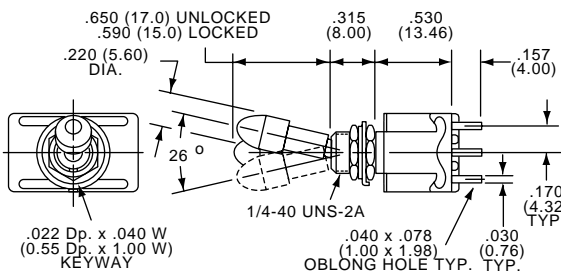

4PDT/DP3T



MTL406N

Model	Type	Act. Code P. M8			
MTL406N	4PDT	4	On	None	On
*MTL406PA	DP3T	12	On	On	On

*Note: PA types have case .100(2.50) longer than other types.

Need more technical information?
Consult your Thomas & Betts
sales office listed on the back cover

Environmental Splashproof Toggle Boot Seals B Series

One piece Neoprene seals bonded on hex nuts in a variety of thread sizes for splash proof & dust tight protection. It's important that proper selection be made to allow free motion of the toggle lever. Custom Neoprene colors and thread sizes available on special order.

1/4-40 & 15/32-32 TOGGLE SWITCH BOOT SEALS
 Splashproof seals especially designed for toggle switches having longer lever actuators. They are also highly recommended for 3-position maintained (not for use with flat toggles) toggle switches where full-cover boots may have a tendency to pull the toggle back to center. No O-Ring required.

Model	Mount Color	Boot Color	Thread Size	Use With Switch Type
BT14400	Black	Black	1/4-40	TT, MTA, Gemini
BT14408	Gray	Gray	1/4-40	TT, MTA, Gemini
BT15320	Black	Black	15/32-32	MTG Series
BT15322	Red	Red	15/32-32	MTG Series
BT15328	Gray	Gray	15/32-32	MTG Series

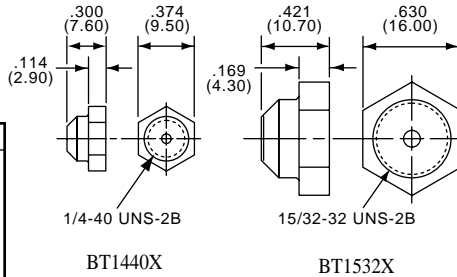

Model	Mount Color	Boot Color	Thread Size	Use With Switch Type
B10480	Black	Black	10-48	TT Series
B10488	Gray	Gray	10-48	TT Series
B14400	Black	Black	1/4-40	TT, MTA, Gemini
B14402	Red	Red	1/4-40	TT, MTA, Gemini
B14408	Gray	Gray	1/4-40	TT, MTA, Gemini

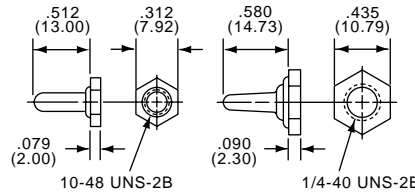

10-48 & 1/4-40 TOGGLE SWITCH BOOT SEALS

Splashproof seals designed for "TINY" and miniature switches with bat toggles up to .370" long. A hex nut is integrally bonded to the Neoprene boot. No O-Ring is required.

1/4-40 TOGGLE SWITCH BOOT SEALS

Splashproof toggle seals having 1/4-40 blind nuts integrally mounted on the Black Neoprene seal. Supplied with captive O-Ring to complete the panel seal. Accepts bat toggles from .375" to .468" long.

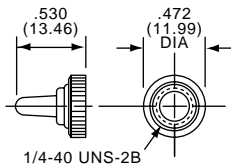

Model	Mount Color	Boot Color	Thread Size	Use With Switch Type
B2100	Nickel	Black	1/4-40	TT, Gemini and MTA Series
B2210	Black	Black	1/4-40	TT, Gemini and MTA Series

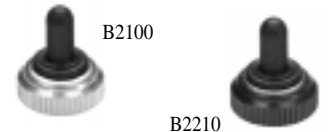

15/32-32 TOGGLE SWITCH BOOT SEALS

Splashproof toggle seals incorporating a molded-in hex nut for water tight & dust tight protection. Recommended for standard size toggle switches with short to medium length toggle levers. Replaces standard hardware usually supplied with switch.

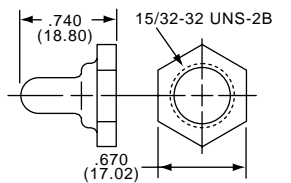

Model	Mount Color	Boot Color	Thread Type	Use With Switch Type
B15320	Black	Black	15/32-32	MTG Series, Gemini "T", "T1" Options
B15322	Red	Red	15/32-32	MTG Series, Gemini "T", "T1" Options
B15328	Gray	Gray	15/32-32	MTG Series, Gemini "T", "T1" Options



15/32-32 TOGGLE SWITCH BOOT SEALS

Splashproof toggle seals having a 15/32-32 hex shaped mount integrally bonded onto the Black Neoprene seal. Supplied with captive O-Ring against the panel. Readily accepts bat toggles from .45" to .7 long.

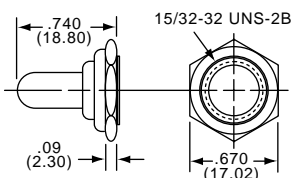

Model	Mount Color	Boot Color	Thread Type	Use With Switch Type
B5880	Nickel	Black	15/32-32	MTG Series, Gemini "T", "T1" Options
B2260	Black	Black	15/32-32	MTG Series, Gemini "T", "T1" Options



Need more technical information?

Consult your Thomas & Betts sales office listed on the back cover